



## NETTOYEUR VAPEUR

**ACCESSOIRES**

+32 (0)71 61 01 90

Commercial@toussaint-industry.com



Allée JF Kennedy 5

5650 Walcourt



**TOUSSAINT-INDUSTRY.COM**

Découvrez notre sélection d'accessoires et de pièces détachées pour OPTIMA STEAMER. Possédez le nettoyeur vapeur le plus vendu au monde.

Accroître son efficacité grâce aux bons outils correspondants à votre domaine d'application.

Découvrez notre gamme d'accessoires.



## [85-50356] Pistolet vapeur K26 avec buse 3.5



Ø3.5 Buse vapeur avec protection en silicone



### Accessoires liés

[85-50202] Tuyau vapeur standard PTFE, 10m

[85-50365] Tuyau vapeur standard PTFE, 15m

[85-50366] Tuyau vapeur standard PTFE, 20m

※ Max. 300cc/min. Vapeur sèche

## [85-50358] Pistolet vapeur Power RL22 avec buse 5.5

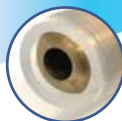

Ø5.5 Buse vapeur avec protection en silicone



### Accessoires liés

[85-50364] Tuyau vapeur power PTFE, 10m

[85-50367] Tuyau vapeur power PTFE, 15m

[85-50368] Tuyau vapeur power PTFE, 20m

※ Max. 600cc/min. Vapeur sèche

► L'utilisation du pistolet vapeur RL22 et du tuyau vapeur Power permet d'augmenter le débit de vapeur de 70 % par rapport au pistolet vapeur K26 et au tuyau vapeur standard.

## Température de vapeur en sortie de pistolet

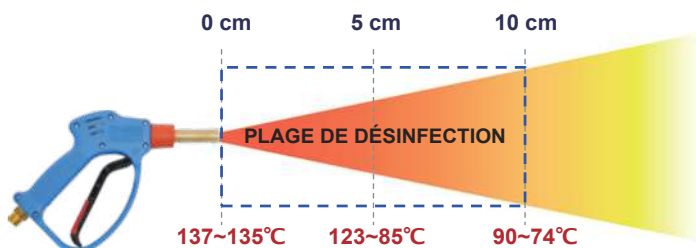

## Pistolet vapeur à rallonge K26 avec buse 3.5

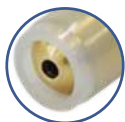

Ø3.5 Buse vapeur avec protection en silicone

**[85-50351]** Pistolet vapeur K26 (300mm)



**[85-50266]** Pistolet vapeur K26 (500mm)



**[85-50354]** Pistolet vapeur K26 (1000mm)



## Pistolet vapeur à rallonge RL22 avec buse 5.5

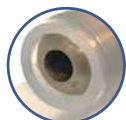

Ø5.5 Buse vapeur avec protection en silicone

**[85-50084]** Pistolet vapeur RL22 (300mm)



**[85-50267]** Pistolet vapeur RL22 (500mm)



**[85-50087]** Pistolet vapeur RL22 (1000mm)



[85-50197] Buse vapeur 3.5 + Poignée, 250D

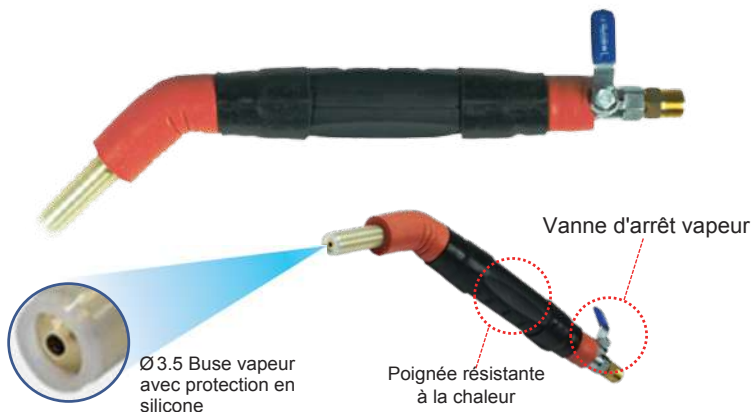

[85-50198] Buse vapeur turbo + Poignée, 250D

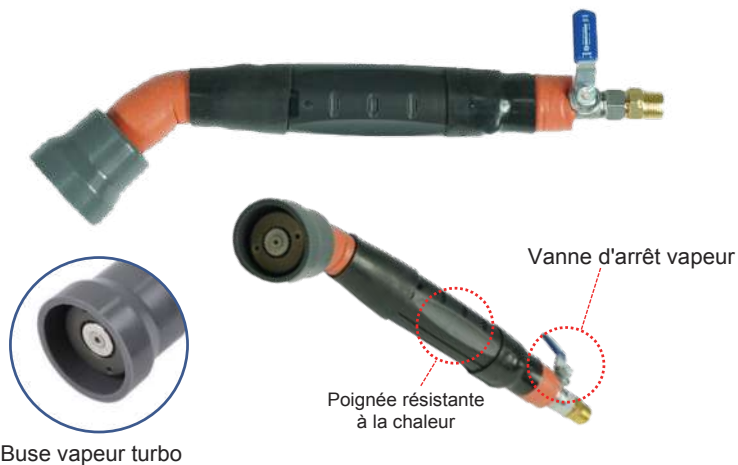



## Attaches rapides pour accessoires

### Pour les accessoires légers

[35-50336]  
SCP30 Quick Plug

[35-50251]  
SC30 Quick Coupler



EXEMPLE



### Pour les accessoires lourds

[35-50040]  
KPS45 Quick Plug

[35-50041]  
KC35 Quick Coupler



EXEMPLE



## Instructions pour attaches rapides

### COMMENT MONTER

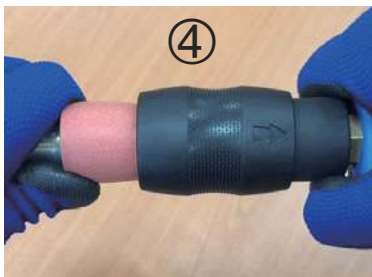
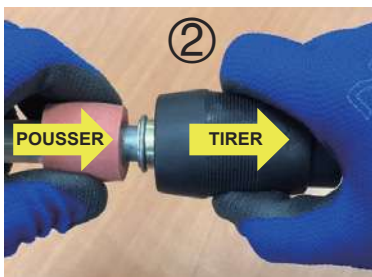
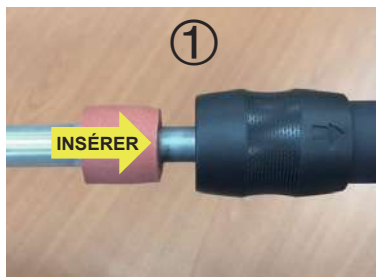

### COMMENT DÉMONTÉ

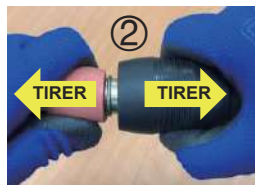

## [85-50253] Pistolet vapeur K26 avec SC30 Quick Coupler



※ Exemple d'usage

SCP30/40  
Quick Plug

SC30  
Quick Coupler



### Accessoires compatibles

[85-50360]

Buse vapeur 3.5



※ Ø3.5 Buse vapeur avec protection silicone

[85-50382]

Buse silencieuse



※ Réduit la pression du jet de vapeur ainsi que le niveau de bruit

[85-50222]

Buse vapeur large



※ Augmente l'angle du jet de vapeur d'environ 60°

### Buses vapeur plates (avec SCP30 Quick Plug)



※ Idéal pour le nettoyage des systèmes de chauffage, ventilation et climatisation (HVAC)

[85-50373] Buse vapeur plate 50



[85-50359] Buse vapeur à jet plat



[85-50212] Buse vapeur plate 100

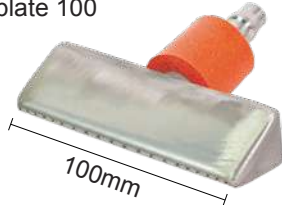

### [85-50254] Buse vapeur turbo (avec SCP40 Quick Plug)



※ Excellent pour un meilleur rendement



# Pistolet vapeur KC35 Quick Coupler (Fortement recommandé)

[85-50047]

Pistolet vapeur K26 avec KC35



※ Exemple d'usage



[85-50130]

Pistolet vapeur RL22 avec KC35



KPS45  
Quick Plug



KC35  
Quick Coupler



## Accessoires compatibles

[85-50145] Buse vapeur 3.5



Ø3.5

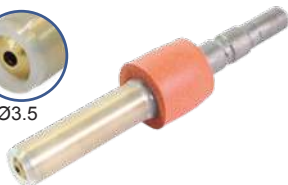

[85-50137] Buse vapeur 5.5



Ø5.5

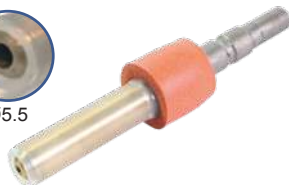

## Rallonge (+buse) 3.5 (avec KPS45 Quick Plug)

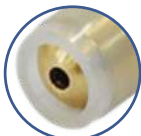

※ Ø3.5 Buse vapeur avec protection en silicone

[85-50079] Rallonge (+ buse) 300mm



[85-50269] Rallonge (+ buse) 500mm



[85-50061] Rallonge (+ buse) 1000mm



## Rallonge (+buse) 5.5 (avec KPS45 Quick Plug)

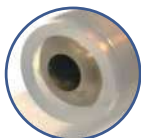

※ Ø5.5 Buse vapeur avec protection en silicone

[85-50190] Rallonge (+ buse) 300mm



[85-50270] Rallonge (+ buse) 500mm



[85-50193] Rallonge (+ buse) 1000mm



## Accessoires compatibles

[85-50274] Balais rotatif sous-châssis



[85-53009] Balais brosse



KPS45  
Quick Plug

※ Nettoyage et assainissement des sols à la vapeur

[85-50056] Balais rotatif (avec KPS45 Quick Plug)



※ Exemple d'usage



※ 3 buses vapeur tournantes



※ La température à l'intérieur du balais est de 100°C



[85-50187] Râteau d'assainissement (avec KPS45 Quick Plug)



※ Stérilisation du sable (plage, terrain de jeu, etc.)

## Rallonge porte brosse (45°) Attaches rapides



**[35-50290]**  
Brosse polyester

**[35-50291]**  
Brosse polyester

**[35-50292]**  
Brosse acier

**[25-50320]**  
Brosse nylon



## Rallonges 45° avec porte brosse (avec KPS45 Quick Plug)



**[85-50076]** Rallonge (+ porte brosse) 100mm (45°)

**[85-50077]** Rallonge (+ porte brosse) 250mm (45°)

**[85-50264]** Rallonge (+ porte brosse) 500mm (45°)

**[85-50064]** Rallonge (+ porte brosse) 700mm (45°)

**[85-50063]** Rallonge (+ porte brosse) 1000mm (45°)

**[85-50194]** Rallonge (+ porte brosse) 1200mm (45°)

## Rallonge porte brosse (0°) Attaches rapides



**[35-50293]**  
Grattoir plastique

**[25-50308]**  
Grattoir acier



## Rallonges 0° avec porte brosse (avec KPS45 Quick Plug)



**[85-50265]** Rallonge (+ porte brosse) 500mm

**[85-50148]** Rallonge (+ porte brosse) 700mm

**[85-50147]** Rallonge (+ porte brosse) 1000mm

**[85-50146]** Rallonge (+ porte brosse) 1200mm

## Accessoires de désherbage



- ※ Éliminez les mauvaises herbes en utilisant uniquement de la vapeur.  
Les accessoires de désherbage injectent de la vapeur à la racine des mauvaises herbes, délivrant une dose concentrée d'humidité à haute température qui commence à tuer les plantes immédiatement, le tout sans utiliser d'herbicides toxiques.  
En quelques jours, les plantes ciblées se flétrissent et meurent, tuées à partir des racines, de sorte qu'elles ne puissent plus repousser.



**[85-50355]** Pistolet vapeur K26 avec buse de désherbage



**[85-50138]** Buse de désherbage (avec KPS45 Quick plug)



[85-50035] Lance de désherbage avec brosse (avec KPS45 Quick Plug)



[85-50036] Lance de désherbage (avec KPS45 Quick Plug)

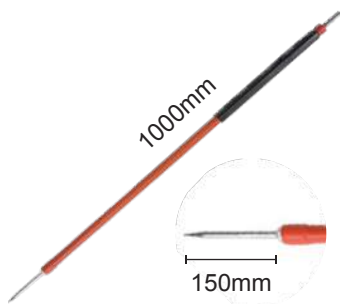

[85-50037] Lance de désherbage plate (avec KPS45 Quick Plug)

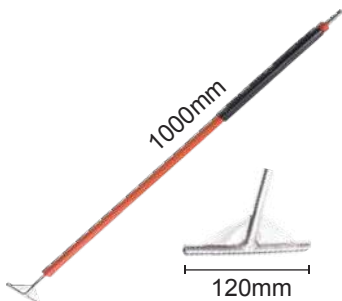

[85-50038] Rouleau de désherbage (avec KPS45 Quick Plug)



## Balai vapeur télescopique avec raclette

- [85-50089] Balai vapeur avec raclette (0.8 à 1.2m)
- [85-50091] Balai vapeur avec raclette (1.4 à 2.4m)
- [85-50092] Balai vapeur avec raclette (1.5 à 3.6m)
- [85-50093] Balai vapeur avec raclette (2.2 à 5.5m)

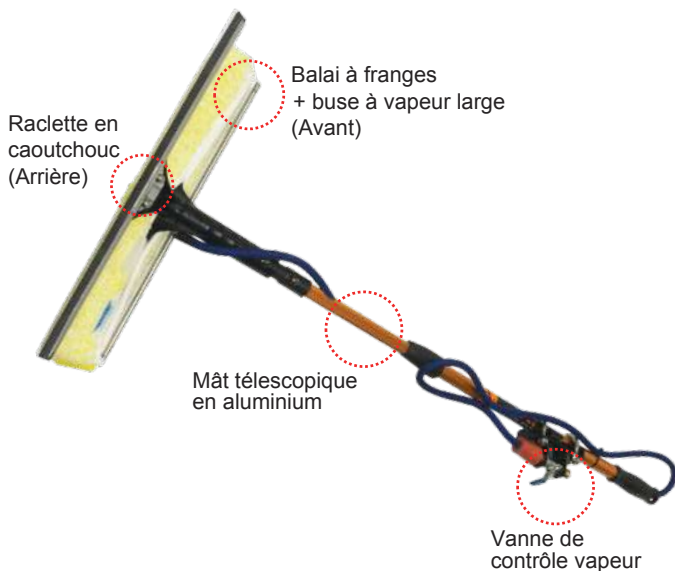

### Pièces détachées

[25-50343] Balai à franges 45cm



[35-50054] Caoutchouc 45cm



## [85-50220] Extracteur vapeur



Accessoire assorti

**[85-50088]**  
Tuyau d'aspiration  
haute température  
(3m)



※ Nettoyage et assainissement des tapis et moquettes en combinaison avec l'aspiration



## [85-50135] Outil vapeur pour tonneaux de vin

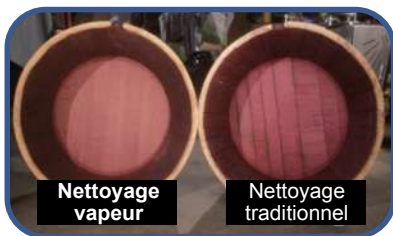

※ L'utilisation de l'Optima Steamer et de notre outil de nettoyage des fûts permet d'utiliser une infime quantité d'eau tout en tuant davantage de bactéries et levures à la surface du fût et dans les pores du bois. Le meilleur nettoyage en profondeur tout en préservant le bois et son caractère.

# Rampe de nettoyage pneumatique pour convoyeur



	85-50201	85-50180	85-50200
Nettoyeur vapeur requis	Optima 42K (SEII) et 27K (SEII, XE)		
Pression de vapeur continue	42K : 7 bar, 27K : 5 bar		
Air comprimée requis	Compresseur, 14.4 CFM @8 bar		
Pression d'air de travail	73~116 psi (5~8 bar)		
Vitesse de travail	150~1000 mm/s		
Convoyeur recommandé	Convoyeurs plastic, métallique, plat ou rouleaux		
Matériel	Aluminium, Acier inoxydable		
(A) Entrée d'air	Prise rapide d'air standard		
(B) Largeur nettoyage, Max.	610 mm	1000 mm	1220 mm
(B) Largeur nettoyage, Min.	100 mm		
(C) Largeur montage, Max.	970 mm	1360 mm	1580 mm
(C) Largeur montage, Min.	300mm		
Dimensions (L x l x H) mm	1320 x 160 x 730	1710 x 160 x 730	1930 x 160 x 730
Dimensions (L x l x H) inch	51.97 x 6.3 x 28.75	67.33 x 6.3 x 28.75	75.99 x 6.3 x 28.75
Poids	12 kg	13.2 kg	14.5 kg

※ Air comprimé nécessaire pour les outils de nettoyage des convoyeurs de type pneumatique

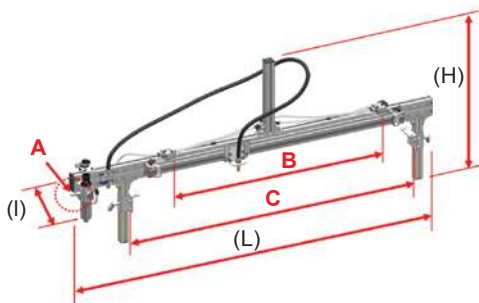

Standard	Large
<b>Fort</b>	<b>Doux</b>



**AVANT**



**APRÈS**

**[85-50082]** Rampe de nettoyage pour convoyeur



**Article similaire**

**[85-50132]** Rampe de nettoyage pour convoyeur (Largeur montage ~1200mm)

**[85-50083]** Rampe de nettoyage pour convoyeur avec aspiration

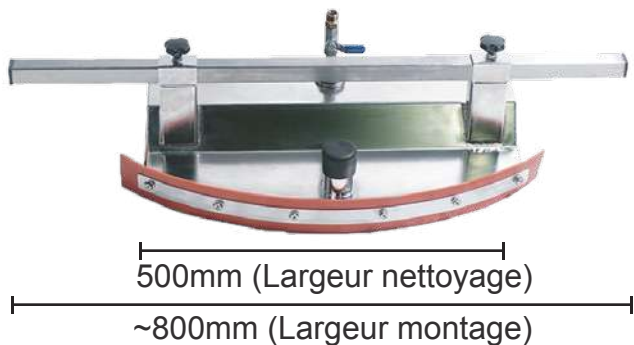

**Article similaire**

**[85-50131]** Rampe de nettoyage pour convoyeur avec aspiration (Largeur montage ~1200mm)

## Pièces et accessoires divers

[88-83011]

Microfibres

Meilleure  
qualité **FBZ**

20 unités

[88-83012]

Microfibres

Tricotée

20 unités

[88-83013]

Microfibres

Laine synthétique

20 unités

[32-21061]

Adaptateur tuyau arrosage



[22-22105]

Protection buse pistolet



[18-83002]

Gants de travail



[85-50005]

Obturbateur K26 + joint torique



[85-50185]

Obturbateur RL22 + joint torique



[85-56026] Adoucisseur d'eau LT5 (avec kit de fixation)



※ Minimisez l'entretien, augmentez la durée de vie de votre machine et économisez de l'argent. Le meilleur moyen d'améliorer la qualité de votre eau est d'utiliser notre adoucisseur d'eau à base de sel, le LT5. Il a été conçu pour être installé à l'arrière de l'Optima Steamer ce qui permet un traitement de l'eau n'importe quand. Obtenez des meilleures performances grâce à l'utilisation d'eau adoucie. Alimenter l'eau directement à l'aide de votre tuyau. La fréquence de recharge varie en fonction de la dureté de l'eau et de la fréquence d'utilisation de la machine. Vous pouvez recharger l'adoucisseur avec du sel de table.



**CONTACTEZ-NOUS**

 +32 (0)71 61 01 90

 [info@toussaint-industry.com](mailto:info@toussaint-industry.com)



Allée JF Kennedy 5  
5650 Walcourt



**TOUSSAINT-INDUSTRY.COM**