

Operator

manual

Installation and Operating Instruction

High Pressure Cleaner - Cold water, mobile

Series KD 2x2



KD523 Standard (DE/UK)



KD523 Premium (DE/UK)

Declaration of Conformity

Manufacturer:

Ehrle GmbH

Address:

**Industriestraße 3
D – 89165 Dietenheim**

Product:
High Pressure Cleaner - Cold water, mobile
Series 2x2

**KD523 (DE/UK) Standard
KD523 (DE/UK) Premium**

The product given below is in conformity with the European Directives:

Relevant EC Directives:

2000/14/EC
2006/42/EC
2011/65/EU
2014/30/EU
2004/108/EC

Applied harmonized standards:

EN 60335-1
EN 60335-2-79
EN 50581
EN 55014-1: 2006+A1: 2009+A2: 2011
EN 55014-2: 2015
EN 62233: 2008
EN IEC 61000-3-2: 2019-12
EN IEC 61000-3-3: 2020-07

Conformity procedures applied:

2000/14/EG: Anhang V

**This product is used like
follows marked:**

**UK UK
CA NI**

CE EAC CE-0085

Dietenheim, 15.01.2023

Development



**Christoph Nöldner
Head of Development**



**Reiner Ehrle
CEO**

Table of content

1	User information	
1.1	General	5
1.2	Functional device concept.....	5
1.3	Terminology.....	6
1.4	Meaning of the emphasis.....	6
1.5	Meaning of the symbols.....	7
1.6	Target group.....	8
1.7	Warranty and Liability.....	9
1.8	Environmental protection.....	10
2	Safety	
2.1	General safety information.....	11
2.2	Authorized persons for device accessg.....	11
2.3	Safety instructions for cleaning operation.....	11
2.4	Accident prevention regulations.....	12
2.5	Lifting and moving loads.....	12
2.6	Periodic inspections.....	13
2.7	Guidelines for liquid sprayers	13
2.8	Design changes to the device.....	13
2.9	Safety devices.....	13
3	Product description	
3.1	Device views Series 2x2, Standard	14
3.2	Device views Series 2x2, Premium.....	15
3.3	Type plate device version Standard.....	16
3.4	Type plate device version Premium.....	16
3.5	Serial number	16
3.6	Technical Data	17
4	Device assembly	
4.1	Accessories for KD523-Standard.....	20
4.2	Accessories for KD523-Premium.....	21
4.3	Device assembly	22
4.3.1	Device version Standard	22
4.3.2	Device version Premium	23
5	Commissioning	
5.1	Select location for device operation	26
5.2	Establishing the water connection	27
5.3	Establishing the electrical mains connection	28
5.4	Commissioning the device.....	29

6	Operation	
6.1	Control and indicator elements of the device.....	30
6.2	Control elements of the trigger gun.....	31
6.3	EMERGENCY STOP switch-off in case of danger.....	31
6.4	Cleaning operation.....	32
6.5	Operation with cleaning detergent (chemistry).....	34
6.5.1	General Informationen.....	34
6.5.2	Cleaning detergent operation.....	35
7	Decommissioning	
7.1	Temporary decommissioning.....	36
7.2	Decommissioning for a longer period of time.....	37
8	Maintenance	
8.1	General Information.....	38
8.2	EHRLE Maintenance and Inspection Contract.....	38
8.3	Maintenance work.....	38
8.3.1	Frost Protection.....	40
8.3.1.1	Drain water from high pressure cleaner.....	40
8.3.1.2	Rinse high pressure cleaner with antifreeze agent.....	40
8.3.2	Filter on the connection water inlet.....	40
8.3.3	Checking the HP-Hoses.....	41
9	Troubleshooting	
9.1	Troubleshooting table.....	42
10	Notes	

1 User information

1.1 General



General information

For a comprehensive advice and information on the High Pressure Cleaner cold water, mobile - Series 2x2 please contact the EHRLE Customer Service.

With the purchase of a EHRLE High Pressure Cleaner cold water, mobile - Series 2x2 you are the owner of a quality product, which is characterised by:

- user-friendliness,
- reliability,
- environmental friendliness.

This Installation and Operating Instruction is part of the High Pressure Cleaner cold water, mobile - Series 2x2 and must be kept at the operating site and be available at all times.

For the High Pressure Cleaner cold water, mobile - Series 2x2, the manual contains information on

- User information
- Safety
- Product information
- Device assembly
- Commissioning, Decommissioning
- Operation
- Maintenance
- Troubleshooting

The German installation and operating instructions are the original version.

1.2 Functional device concept

Due to the specific constructive properties the high pressure cleaners can be used in all conceivable industries, for example:

- Industry
- Agriculture and forestry
- Painting companies (e.g. facades, floors)
- Construction companies (structural engineering, underground construction and road construction)
- Forwarding companies, vehicle and rental parks
- Local government
- Hotels and restaurants, as well as food industry.

1.3 Terminology

In this manual the terminology listed below is replaced by the relevant short terms whenever possible

- High Pressure Cleaner cold water, mobile - Series 2x2 high pressure cleaner or device
- Installation and Operating Instruction manual
- High pressure hose HP-Hose

If a clear reference to a subject is required in the description parts, the terminology „High Pressure Cleaner cold water, mobile - Series 2x2“ is used.

1.4 Meaning of the emphasis

The emphasis used in this manual have the following meanings:

WARNING

Warning precedes operating procedures, instructions, etc., which, if not strictly observed, could result in personal injury or loss of life. Warning precedes also, when device misuse could result in personal injury or loss of life.





CAUTION









Caution precedes operating procedures, instructions, etc., which, if not strictly observed, could result in damage to the high pressure cleaner. Caution precedes also, when device misuse could result in damage to the high pressure cleaner.



This symbol indicates additional information.

1.5 Meaning of the symbols

Symbol	Meaning
	<p>WARNING Follow instructions!</p> <p>Non-observance or neglecting of prescribed instructions, incorrect operation or misuse of the device may endanger life and limb of persons.</p>
	<p>WARNING Danger of death due to electric shock.</p> <p>Do not open the device. During operation, dangerous voltages are present on live parts of the device.</p> <p>Touching live parts can lead to life-threatening injuries.</p>
	<p>WARNING Danger of burns and scalds.</p> <p>When operating with a water inlet temperature of up to 45 °C the cleaning objects, the hot water emerging from the trigger gun, surfaces of the cleaning objects or device components can become hot.</p> <p>Touching hot surfaces or hot water can cause burns or scalding of the skin surface. Make sure surfaces have cooled before touching.</p> <p>The hot water escaping from the trigger gun must not come into contact with the skin.</p>
	<p>WARNING Explosion hazard due to use of unauthorised cleaning agents.</p> <p>Never aspirate liquids containing solvents such as paint thinners, petrol, oil or similar liquids.</p> <p>The spray mist of solvents is highly flammable, explosive and toxic.</p> <p>Follow the instructions of the additive manufacturer!</p>
	<p>WARNING Danger with heavy loads.</p> <p>A person is not allowed to lift and move loads more than 23 kg. Otherwise the health of persons may be endangered (e.g. overload of the spinal column, injuries from falling loads).</p> <p>For loads of more than 23 kg, use suitable lifting equipment (e.g. forklift truck, lift truck).</p>

Symbol	Meaning
	<p>CAUTION Observe instructions for installation, device adjustment, operation, maintenance and repair.</p> <p>Non-observance or neglecting prescribed instructions, incorrect operation or misuse of the device may result in damage to device parts, assemblies or components.</p>
	<p>General Information General additional information.</p>
	<p>Information on recycling General information on recycling.</p>
	<p>Information zur Entsorgung Allgemeine Informationen zum sach- und umweltgerechten Entsorgen von Materialien und Verbrauchsstoffen.</p>
	<p>Information zum Gehörschutz Allgemeine Informationen zum Gehörschutz.</p>
	Requires direct action.
	Result after an action.
	Itemisation

1.6 Target group

This Installation and Operating Instruction contains information for operating personnel for carrying out

- device mounting in the delivery state
- general cleaning works.

1.7 Warranty and Liability

The EHRLE High Pressure Cleaner cold water, mobile - Series 2x2 may only be used for its intended purpose.

Intended use includes:

- Operation only by authorised persons who
 - are instructed and trained on the device, or
 - have completely read and understood the information and instructions in this Installation and Operating Instruction and can therefore guarantee safe handling of the device.
- The information and instructions contained in this manual must be observed.
- If the safety and protective devices are faulty, the high pressure cleaner must not be put into operation.
- The high pressure cleaner may only be operated with fully functional safety and protective devices. In the event of functional failures during operation, the high pressure cleaner must be taken out of operation immediately.
- Faulty, insufficient or defective high pressure cleaners must not be put into operation. Before commissioning, carry out a visual inspection for faulty or defective
 - device parts, assemblies or components
 - electrical cables
 - HP-Hoses.
- The high pressure cleaner must be switched off immediately and taken out of operation if defects, faults or deficiencies occur on
 - device parts, assemblies or components
 - electrical cables
 - HP-Hoses.
- No constructive changes may be made to the device.
- The device may only be operated in the configuration certified by the manufacturer. Operation with subsequently installed modules, components or additional devices is not permitted and may endanger life and limb of persons or lead to damage to the device.
- Only original parts from the manufacturer or consumables approved by the manufacturer may be used for maintenance and repair work.

Any warranty and liability claims for personal injury and damage to the device are void if the high pressure cleaner is not used for its intended purpose.

1.8 Environmental protection



Note on recycling

The packaging materials are recyclable. Please do not throw the packaging into the household waste, but recycle it.



Note on disposal

Old appliances contain valuable recyclable materials which should be recycled. Batteries, oil and similar materials must not be discharged into the environment.

For this reason, please dispose of old appliances using suitable collection systems.

Dispose of used materials in an appropriate and environmentally friendly manner. Observe the local regulations.

According to environmental regulations, waste water containing mineral oil, fuels for hot water heating or lubricants such as oils and greases must not enter the soil, water or sewerage system.

Do not allow engine oil, fuel oil or petrol to escape into the environment. Protect the soil and dispose of used oil in an environmentally friendly manner.

Engine cleaning or underbody washing of all types of vehicles may only be carried out at washing stations equipped with oil separators in accordance with environmental regulations (environmental protection).

2 Safety

2.1 General safety information

Observe the respective national regulations of the legislator for liquid sprayers.

Observe the relevant national regulations of the legislator on accident prevention. Liquid sprayers must be inspected regularly and the result of the inspection must be recorded in writing.

Observe the safety instructions provided with the cleaning agents used (usually on the packaging label).

Keep cleaning agents out of the reach of unauthorized persons. Risk of poisoning or caustic burns from cleaning agents! Observe the instructions on the cleaning agents.

Perform prescribed maintenance and inspection work in due time (see Section 8, Maintenance).

Safety-relevant defects must be rectified immediately. Keep all signs on the device legible.

2.2 Authorized persons for device access

Ensure that access to the device is only possible for the persons who

- have completely read and understood the information and instructions in this Installation and Operating Instruction and can therefore guarantee safe handling of the device or
- are instructed and trained on the device.

Children as well as persons with reduced physical, sensory or mental abilities are not allowed to operate the device.

2.3 Safety instructions for cleaning operation

During cleaning work, the personnel at the workplace must wear the necessary Personal Protective Equipment (PPE). This includes waterproof protective suits, rubber boots, protective goggles, headgear, ear protection if necessary, etc.

No cleaning work may be carried out in the presence of persons without sufficient PPE.

Before switching on, carry out a visual inspection of the device parts from the outside for damage (HP-Hose, electrical or mechanical parts). Devices with damaged parts, assemblies or components must not be put into operation.

The water jet leaving the trigger gun must not be directed at

- persons
- animals
- live electrical installations (building mains connections, sockets, electrical wiring, etc.)
- live electrical installations, machines, devices, assemblies or components
- system, machinery or equipment in operation.

Under the influence of the high pressure jet, parts can be separated from the cleaning object and thrown away. Persons can be injured as a result.

Never aim the high pressure jet at fragile or loose objects.

When cleaning tyres and their valves, keep a minimum distance of 30 cm from the high pressure nozzle. Otherwise damage may occur.

Before cleaning the High Pressure Cleaner cold water, mobile - Series 2x2 itself, take the device out of operation and disconnect it from the electrical mains connection. Secure the device against unintentional or unauthorised restarting (e.g. lock main switch, disconnect mains cable from power outlet, provide warning sign indicating work on the high pressure cleaner, etc.).

Never operate the device unattended.

The device is designed for a water inlet temperature of up to 45 °C. When operated with hot water, water carrying parts (for example pump housing, uninsulated pipes, metal parts of the trigger gun and spray lance) as well as cleaning objects may become hot. Touching hot surfaces can cause burns or scalding of the skin surface. Make sure surfaces have cooled before touching. The hot water escaping from the trigger gun must not come into contact with the skin.

Asbestos-containing and other materials containing substances hazardous to health must not be sprayed off.



Information on hearing protection.

If the sound levels exceed the permissible values, the personnel and persons in the area of exposure must wear hearing protection.

The sound level for EHRLE high pressure cleaners under maximum load is 82 dB (A). A high sound level over a long period can cause hearing loss. If the noise produced by the application of the emerging high pressure jet to noise-enhancing objects exceeds the permissible values, the operating personnel and any persons affected must wear hearing protection.

Do not operate the device if electrical cables or other safety-relevant parts (pressure relief valve, HP-Hose, trigger gun, etc.) are defective.

2.4 Accident prevention regulations

Observe the applicable national regulations of the legislator on accident prevention.

2.5 Lifting and moving loads

The High Pressure Cleaner cold water, mobile - Series 2x2 weighs from 33 to 35 kg depending on the type (with packaging from approx. 37 kg to 39 kg).

Lifting and moving loads is permitted for one person up to 23 kg. If the load exceeds 23 kg use suitable lifting equipment (e.g. forklift, lift trucks).

Observe the international standard „ISO 11228-1 Ergonomie - Manuelles Handhaben von Lasten - Teil 1 Heben und Tragen 05/2003“.

2.6 Periodic inspections

The periodic inspections are listed in Section 8 (Maintenance).

2.7 Guidelines for liquid sprayers

High pressure cleaners must be inspected by an expert in accordance with the „Guidelines for liquid sprayers“, if necessary or at least every 12 months. The result of the test must be recorded in writing.

In the appendix of this manual there is a test sheet (proof of customer service) to record the tests carried out.

EHRLE service technicians are experts and can be consulted and commissioned by EHRLE service for this prescribed inspection.

2.8 Design changes to the device

Design changes to the high pressure cleaner are not permitted.

Inadmissibly constructively modified devices can endanger the life and limb of persons.

When operating a device which has been modified or changed in design, the device will not be used for its intended purpose. If the device is not used for its intended purpose, no liability or warranty will be accepted (see Section 1.7, Warranty and Liability).

2.9 Safety devices

Safety devices serve to protect the user and must not be suspended or circumvented in their function.

The high pressure cleaner has the following safety devices listed below:

- Pressure switches:
Device functions are switched on or off (safety functions) based on type of construction and intended use.
- Unloader valve and non-return valve:
The first serves to adjust the operating pressure and the second valve keeps the pump head depressurised when the trigger gun is deactivated.
- TSS system with pump-off delay:
After deactivating the trigger gun, the pump continues operation for approx. 30 s in the pressureless bypass mode (avoidance of too high pressure build-up in the pump); after 30 s the high pressure cleaner automatically switches into the stand-by mode.
- Total Switch-off:
Automatically switches the high pressure cleaner off in the event of prolonged interruption of operation or unused trigger gun for more than 20 minutes.
- Overload protection switch:
When the motor current load is too high the switch releases and the device is switched off.
- Mechanical arrest for trigger gun:
Prevents unintentional or unconscious activating the trigger gun.

3 Product description

3.1 Device views Series 2x2, Standard

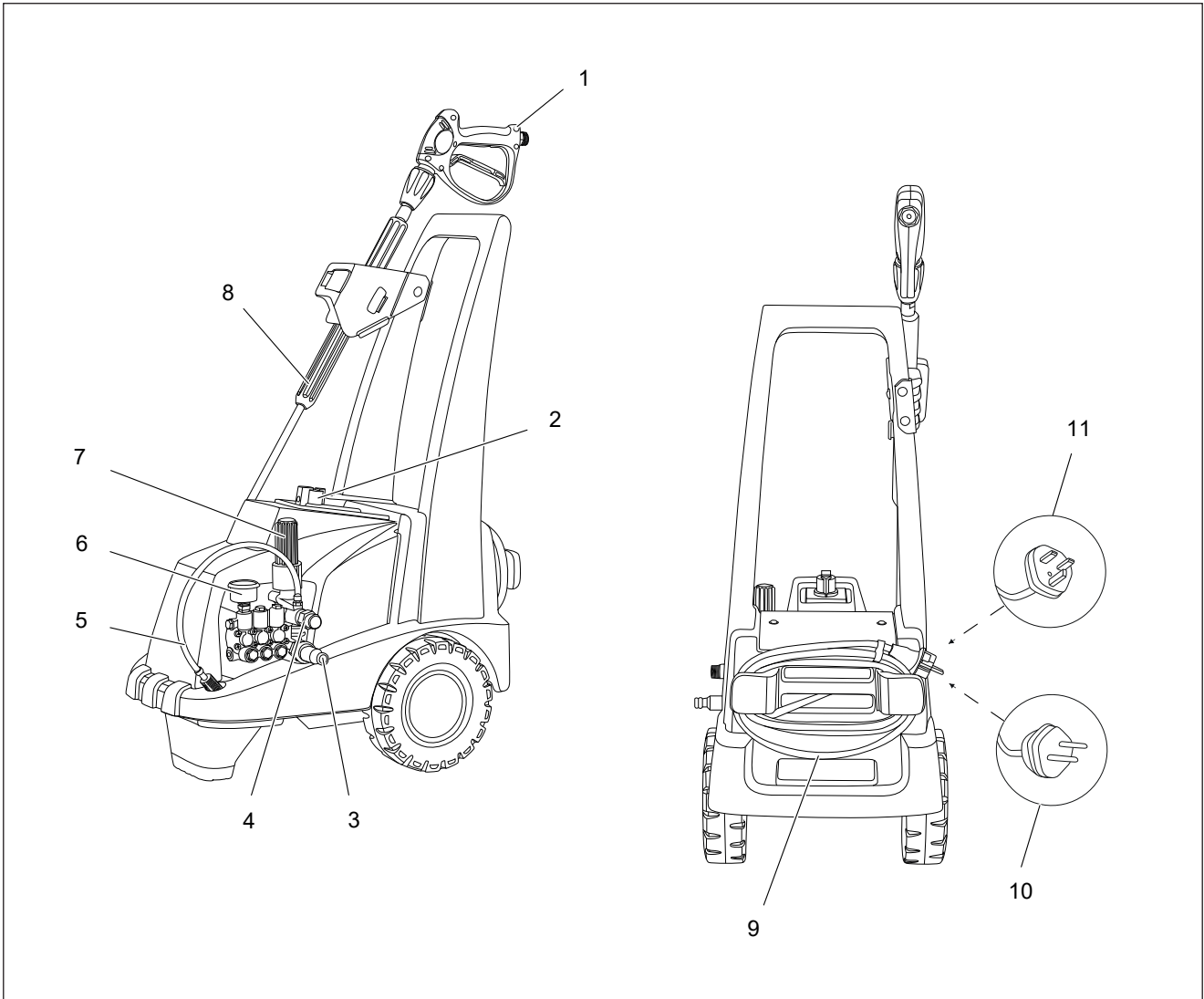

- | | | | |
|---|------------------------------------|----|--------------------------------------|
| 1 | Trigger gun | 7 | Unloader valve |
| 2 | Device switch On/Off | 8 | Spray lance 900 mm with vario nozzle |
| 3 | Connection water inlet with filter | 9 | Power cord |
| 4 | High pressure outlet (pump) | 10 | Power plug 230 V |
| 5 | Detergent suction hose with filter | 11 | UK power plug 240 V |
| 6 | Pressure gauge | | |

Fig. 3 - 1 KD523 Standard, total and rear view

3.2 Device views Series 2x2, Premium

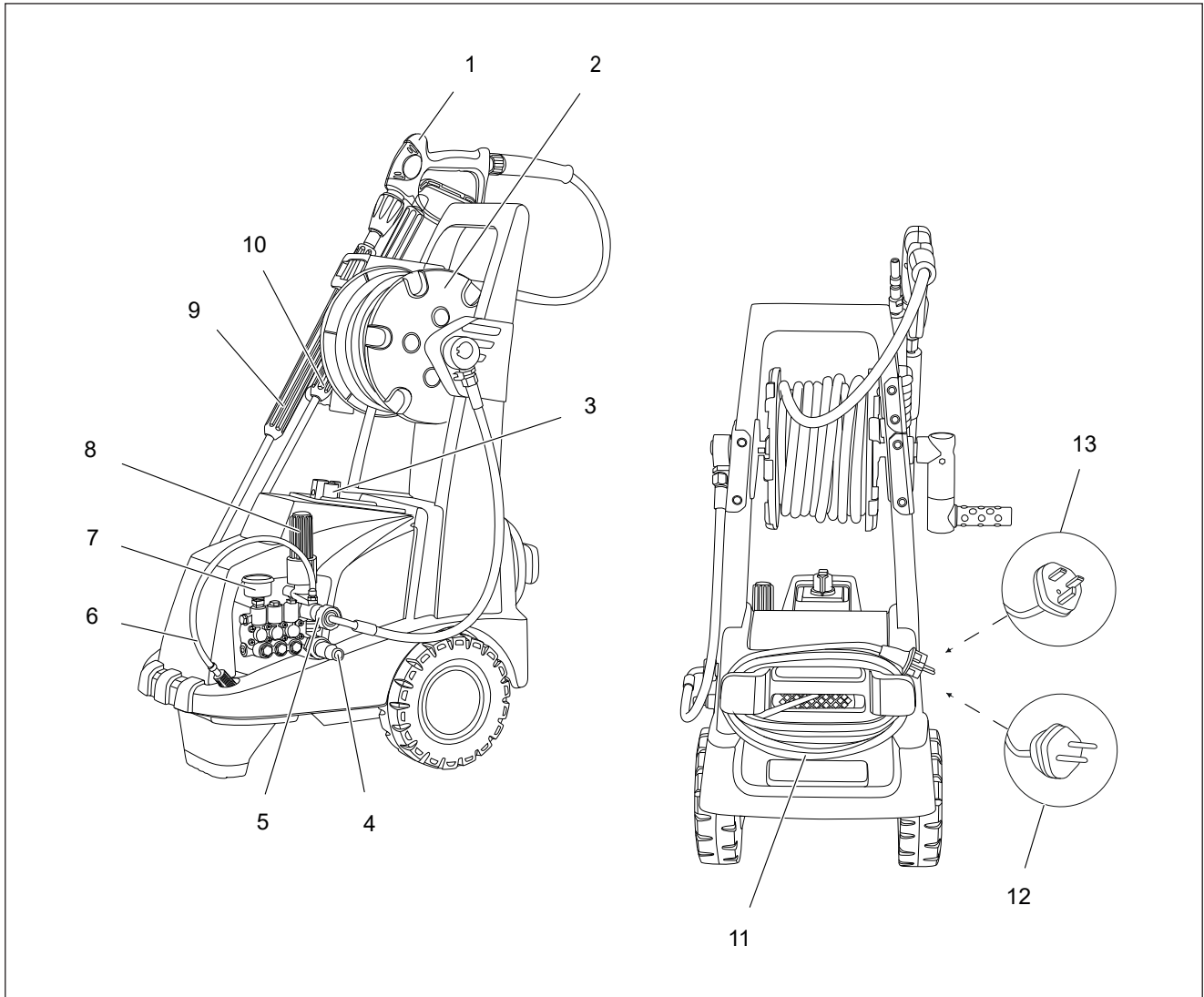

- | | | | |
|---|------------------------------------|----|---------------------------------------|
| 1 | Trigger gun | 8 | Unloader valve |
| 2 | Hose reel | 9 | Spray lance 900 mm with rotary nozzle |
| 3 | Device switch On/Off | 10 | Spray lance 900 mm with vario nozzle |
| 4 | Connection water inlet with filter | 11 | Power cord |
| 5 | High pressure outlet (pump) | 12 | Power plug 230 V |
| 6 | Detergent suction hose with filter | 13 | UK power plug 240 V |
| 7 | Pressure gauge | | |

Fig. 3 - 2 KD523 Premium, total and rear view



3.3 Type plate device version Standard

KD523-Standard

Type: KD523-Standard
559001-XX-B



Voltage	1/N/PE/AC/50Hz/230/240V
Operating pressure	30-140bar/ 3-14MPa
Max. pressure	155bar/ 15,5MPa
Discharge capacity	300 - 600 l/h
Nozzle size	043
Max. Inlet temp.	45°C
Pump speed	2800rpm
Connected load	2,9kW / 12,5A
ISO-Class	F / S1
Electrical protection	16A slow





Serial No.: 100010101 87204



EHRLE GmbH | Industriestraße 3 D-89165 Dietenheim
 Tel.: 0 73 03 / 16 00-0 | Fax: 0 73 03 / 16 00-600

KD523-UK-Standard

Type: KD523 UK-Standard
559003-XX-B



Voltage	1/N/PE/AC/50Hz/230/240V
Operating pressure	30-140bar/ 3-14MPa
Max. pressure	155bar/ 15,5MPa
Discharge capacity	300 - 600 l/h
Nozzle size	043
Max. Inlet temp.	45°C
Pump speed	2800rpm
Connected load	2,9kW / 12,5A
ISO-Class:	F / S1
Electrical protection	13A slow

Serial No.: 101110110 87204

EHRLE GmbH | Industriestraße 3 D-89165 Dietenheim
 Tel.: 0 73 03 / 16 00-0 | Fax: 0 73 03 / 16 00-600



3.4 Type plate device version Premium

KD523-Premium

Type: KD523-Premium
559002-XX-B



Voltage	1/N/PE/AC/50Hz/230/240V
Operating pressure	30-140bar/ 3-14MPa
Max. pressure	155bar/ 15,5MPa
Discharge capacity	300 - 600 l/h
Nozzle size	043
Max. Inlet temp.	45°C
Pump speed	2800rpm
Connected load	2,9kW / 12,5A
ISO-Class:	F / S1
Electrical protection	16A slow





Serial No.: 110010110 87204



EHRLE GmbH | Industriestraße 3 D-89165 Dietenheim
 Tel.: 0 73 03 / 16 00-0 | Fax: 0 73 03 / 16 00-600

KD523-UK-Premium

Type: KD523 UK-Premium
559004-XX-B



Voltage	1/N/PE/AC/50Hz/230/240V
Operating pressure	30-140bar/ 3-14MPa
Max. pressure	155bar/ 15,5MPa
Discharge capacity	300 - 600 l/h
Nozzle size	043
Max. Inlet temp.	45°C
Pump speed	2800rpm
Connected load	2,9kW / 12,5A
ISO-Class:	F / S1
Electrical protection	13A slow

Serial No.: 101010101 87204

EHRLE GmbH | Industriestraße 3 D-89165 Dietenheim
 Tel.: 0 73 03 / 16 00-0 | Fax: 0 73 03 / 16 00-600

3.5 Serial number

The serial number on the type plate uniquely identifies the product. It is required for Ehrle customer service.

3.6 Technical Data

High Pressure Cleaner cold water, mobile - Series 2x2 / Series 2x2 UK

		Version	Version
		Standard / Premium	Standard / Premium
		KD523	KD523 UK
Electrical connection			
Mains voltage	V	230	240
Phase	~	1	1
Mains frequency	Hz	50	50
Connected load	kW	2,9	2,9
Current (max.)	A	13,2	12,9
Degree of protection	IP	IPX5	IPX5
Main fuse (slow-blowing)	A	16	13
Residual current circuit breaker (max. allowed residual current)	mA	30	30
Extension cable up to 20 m	Wires	3 x	3 x
	mm ²	2,5	2,5
Water connection			
Max. feed pressure	bar	5	5
	MPA	0,5	0,5
Max. feed temperature	° C	45	45
Feed volume	l/min	10	10
Suction height	m	0	0
Performance data device			
Nozzle size	---	043	043
Operating pressure	bar	30 - 140	30 - 140
	MPA	3 - 14,0	3 - 14,0
Max. operating over-pressure	bar	155	155
	MPA	15,5	15,5
Discharge capacity	l/h	300 - 600	300 - 600
Recoil force trigger gun	N	33,2	33,2
Pump speed	U/min	2800	2800

Tab. 3 - 1 Technical data for High Pressure Cleaner cold water, mobile - Series 2x2/Series 2x2 UK

		Version	Version
		Standard / Premium	Standard / Premium
		KD523	KD523 UK
Masse und Abmessungen			
Weight			
Standard (with packaging)	kg	33 (37)	33 (37)
Premium (with packaging)	kg	35 (39)	35 (39)
Length (with packaging)	mm	400 (420)	400 (420)
Width (with packaging)	mm	600 (660)	600 (660)
Height (with packaging)	mm	860 (960)	860 (960)
Lubricant			
Amount of oil	l	0,18	0,18
Oil grade	Type	10W40	10W40

Tab. 3 - 1 Technical data for High Pressure Cleaner cold water, mobile - Series 2x2/Series 2x2 UK

4 Device assembly



WARNING

Ensure correct device assembly.

The persons assembling the high pressure cleaners must have

- read this manual and understood, that error-free device assembly can be guaranteed, or
- specially trained and instructed on the respective device.

Otherwise, the life and limb of persons may be endangered.



WARNING

Danger with heavy loads.

The High Pressure Cleaner cold water, mobile - Series 2x2 weigh depending on type from 33 kg to 35 kg (with packaging 37 kg to 39 kg).

A person is not allowed to lift and move loads (e.g. devices, assemblies) more than 23 kg.

Otherwise the health of persons may be endangered (e.g. overload of the spinal column, injuries from falling loads).

For loads of more than 23 kg, use suitable lifting equipment (e.g. forklift, lift truck).



General Information

For detailed advice and information on the device assembly of the High Pressure Cleaner cold water, mobile - Series 2x2, please contact the EHRLE customer service.

4.1 Accessories for KD523-Standard





 <p>High pressure cleaner</p>	 <p>Spray lance 900 mm with vario nozzle</p>	 <p>Trigger gun</p>	 <p>HP-Hose DN6 10 m</p>
 <p>Water inlet filter</p>			

Fig. 4 - 1 Accessories for KD523-Standard

4.2 Accessories for KD523-Premium







 <p>High pressure cleaner</p>	 <p>Spray lance 900 mm with vario nozzle</p>	 <p>Spray lance 900 mm with rotary nozzle</p>	 <p>Trigger gun</p>
 <p>HP-Hose DN6 15 m</p>	 <p>Water inlet filter</p>		

Fig. 4 - 2 Accessories for KD523-Premium

4.3 Device assembly

4.3.1 Device version Standard



General information

The following assembly instruction provides a general example of assembling the device version Standard.

For device assembly proceed as follows:

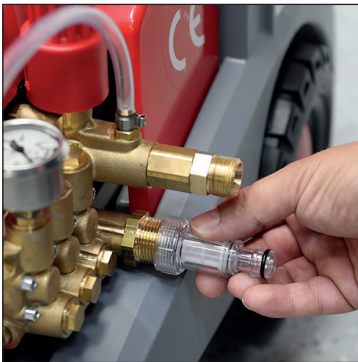

- ▶ Provide the filter to the water inlet
 - Mount the filter to the water inlet.



- ▶ Connecting HP-Hose to the pump
 - Connect the HP-Hose to the high pressure outlet of the pump.



- ▶ Connecting the HP-Hose to the trigger gun
 - Attach the hose end with the bend protection to the trigger gun and tighten by hand.



- ▶ Mounting the trigger gun onto the spray lance
 - Pull back the quick lock (see figure lower left) of the trigger gun and insert the lance.
 - After inserting the lance, make sure that the quick lock arrests fully forward again.



- ▶ Connecting to the water supply net
 - For the water supply, connect the water supply hose 1/2" (DN13) to the filter.

4.3.2 Device version Premium



General information

The following assembly instruction provides a general example of assembling the device version Premium.

For device assembly proceed as follows:

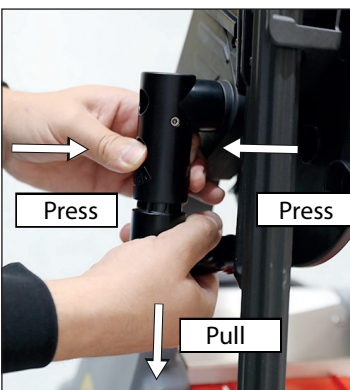

- ▶ Unlocking the hose reel
 - Press in the locking buttons with the thumb and index finger and at the same time pull the handle out of the locking.



- ▶ Moving crank handle to the working position
 - Turn the handle 180 ° into the working position.



- ▶ Engage crank handle in the end position
 - Let the crank handle engage again in the end position.



- ▶ Mounting the HP-Hose to the hose reel
 - Unwind HP-Hose and lay out straight.
 - Attach the HP-Hose with the hose end without bend protection by hand to the connection in the middle of the hose reel.

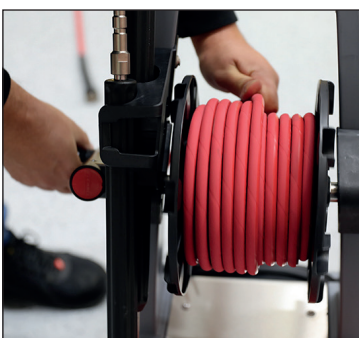

- ▶ Rolling up the HP-Hose
 - Wind the HP-Hose evenly and layer by layer on the hose reel as shown in the figure.



- ▶ Provide the filter to the water inlet
 - Mount the filter to the water inlet.

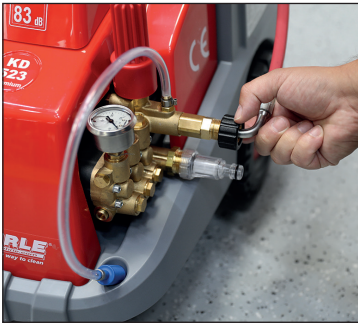

- ▶ Attaching connection hose to the pump outlet
 - Attach the connection hose to the high pressure pump outlet and tighten by hand.



- ▶ Connecting the HP-Hose to trigger gun
 - Attach the hose end with the bend protection to the trigger gun and tighten by hand.



- ▶ Mounting the trigger gun onto the spray lance
 - Pull back the quick lock (see figure lower left) of the trigger gun and insert the lance.
 - After inserting the lance, make sure that the quick lock arrests fully forward again.

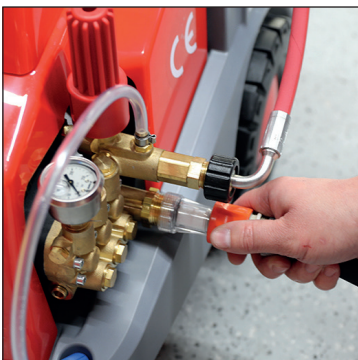

- ▶ Connecting to the water supply net
 - For the water supply, connect the water supply hose 1/2" (DN13) to the filter.

5 Commissioning



WARNING

Commissioning must be carried out professional.

For commissioning, operators must follow the instructions in this section. Otherwise the life and limb of persons may be endangered.

The Ehrle high pressure cleaners are subjected to a final test for correct function and safety before delivery.

The first commissioning and the first cleaning operation serve to check the correct functioning of the device, if damage to components that is not immediately visible during transport has occurred.

If the device functions incorrectly, consult the EHRLE customer service immediately.

5.1 Select location for device operation



WARNING

Select a suitable and permissible operating location.

The local regulations concerning the installation and operation of the device must be observed.

The devices listed in this manual must not be set up and operated in rooms or areas subject to fire or explosion hazards.

When selecting the location for device operation observe:

- The socket for the mains cable connection must be within easy reach (provide an extension cable if necessary).
- Water inlet hose of sufficient length for connection to fittings of the water supply network or water tap.
- Select a suitable washing place for the cleaning object.

Do not set up the device in very wet areas (e.g. areas with puddles) or operate it under water. Do not lay cables and cable plugs in wet areas.

5.2 Establishing the water connection



CAUTION

Do not operate the device with contaminated or too hot water.

Operate the high pressure cleaner only with clear and unpolluted water. The water inlet temperature to the device may be max. 45 °C. Dirty or too hot water can damage the high pressure cleaner.



General Information

For the device version Standard, the manufacturer recommends equipping the connection fitting of the water supply network or the adapter of the water connection hose with a filter.

In case of suction operation from a water reservoir, provide a filter in the water inlet.

The building water connection (tap water network) for the water supply of the high pressure cleaner must be designed for trouble-free constant operation (see Section 3.6, Technical Data).

The regulations of the relevant water supply company must be observed! According to EN 61 770, the high pressure cleaner must not be directly connected to the public drinking water supply. However, according to DVGW (Deutscher Verband des Gas- und Wasserfaches - German Gas and Water Association), short-term connection is permissible if a backflow preventer with a pipe ventilator is installed in the supply line.

Water after the backflow preventer is no longer considered drinking water.

An indirect connection to the public drinking water supply is also permissible by means of a free outlet. The water supply must comply with EN 61 770, e.g. by using a tank with a float valve. Direct connection to a pipe network not intended for drinking water supply is permissible.

The environmental, waste and water protection regulations must be observed by the system operator!

Equip the water connection of the tap water network with a shut-off valve.

Connect the high pressure cleaner to the water connection via the water supply hose.

5.3 Establishing the electrical mains connection



WARNING

Ensure that the electrical connection is properly installed.

Only connect the device to voltage sources earthed in accordance with the safety regulations (mains connection of buildings or mains junction box e.g. on construction sites).

The connection plugs must not lie on the floor and must always be dry. Do not touch the connectors with wet hands.

All live parts in the intended working area for cleaning work, e.g. devices, cables, sockets etc. must be water-jet proof in accordance with the safety regulations.

Depending on device, the electrical mains connection (mains connection of buildings or mains junction box e.g. on construction sites) must adhere the Technical Data (see Section 3.6) and

- comply with the electrical values indicated on the type plate of the device
- ensure trouble-free constant operation.

The mains connection must be equipped with a residual current circuit breaker 30 mA and protected via circuit breaker as follows

- DE Version: Mains voltage 230 VAC with 16 A (slow blow)
- UK Version: Mains voltage 240 VAC with 13 A (slow blow).

The high pressure cleaner is supplied with a 5 m long mains cable.

When using extension cables, the relevant national safety regulations must be observed. The cross section of the individual cable wires for extension cables must be at least

- 1,5 mm² for a length up to 10 m
- 2,5 mm² for a length more than 10 m.

Use extension cable H07RN-F 3 G, 1,5 mm² or 2,5 mm². The plug connections must be water-jet proof in accordance with safety regulations.

When using a cable drum, the extension cable must always be unwound completely.

For the electrical connection proceed as follows:

- ▶ Make sure, the device switch On/Off (2, Fig. 6 - 1) is switched off (position 0).
- ▶ Unwind the mains cable from the holder and place it on the floor. When using extension cables, unwind the cable from the drum and place it on the floor.
- ▶ Plug the mains cable plug into the socket.

For the electrical connection proceed as follows:

- ▶ Make sure, the device switch On/Off (2, Fig. 6 - 1) is switched off (position 0).

- ▶ Unwind the mains cable from the holder and place it on the floor. When using extension cables, unwind the cable from the drum and place it on the floor.
- ▶ Plug the mains cable plug into the socket.

5.4 Commissioning the device

For commissioning the device proceed as follows:

- ▶ Open the water supply from the tap water network via the shut-off valve.
- ▶ Switch on the mains voltage via the main switch or circuit breaker of the mains connection (e.g. building connection or mains junction box e.g. on construction sites).
- ▶ To operate and perform cleaning work with the high pressure cleaner, proceed as given in Section 6 (Operation).

6 Operation

6.1 Control and indicator elements of the device

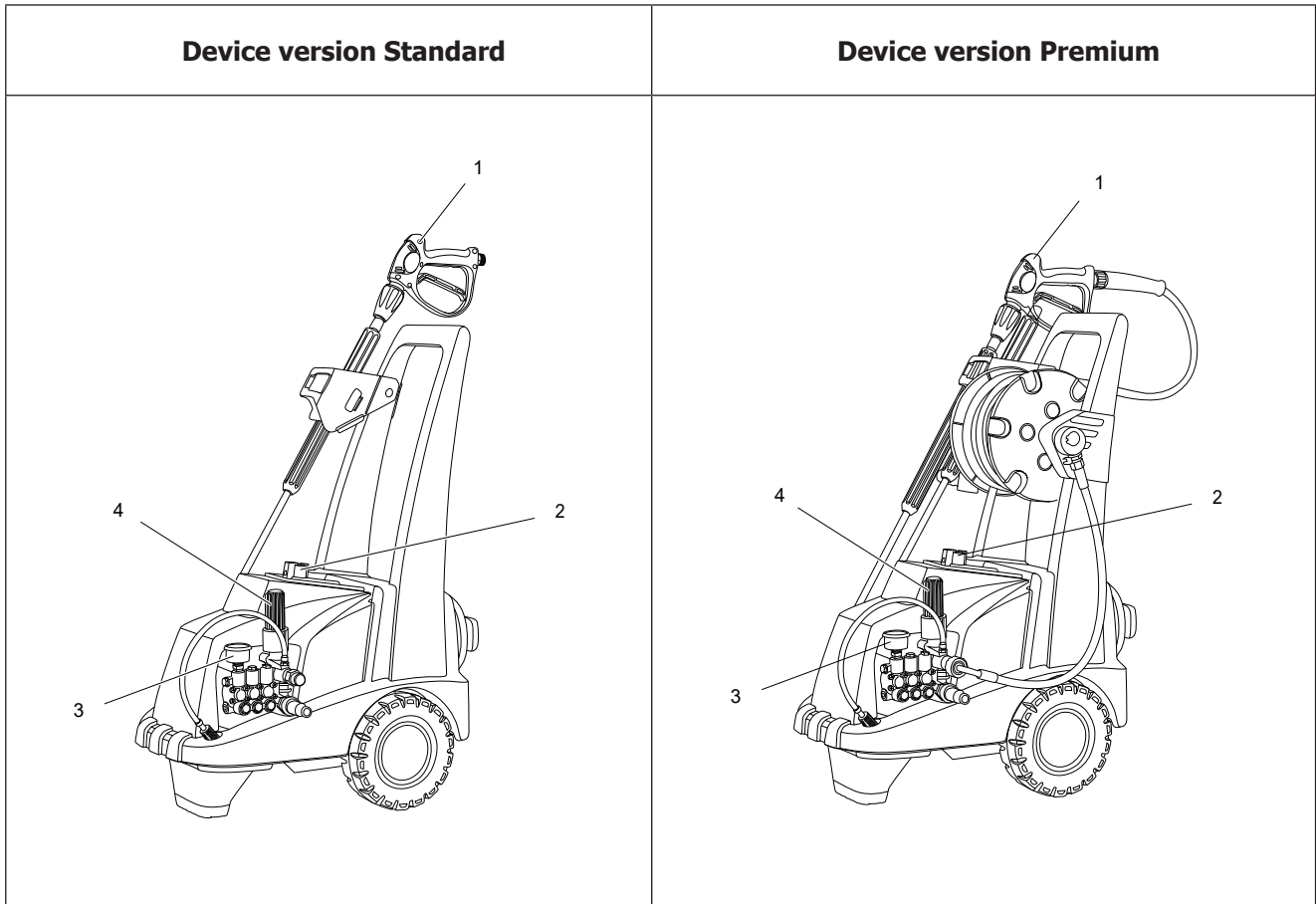

- | | |
|------------------------|------------------|
| 1 Trigger gun | 3 Pressure gauge |
| 2 Device switch On/Off | 4 Unloader valve |

Fig. 6 - 1 Control and indicator elements, device version Standard and Premium

6.2 Control elements of the trigger gun

The following figure shows the control elements of the trigger gun.

To assemble (disassemble) the spray lance to the (from the) trigger gun see arrows in the figure below.

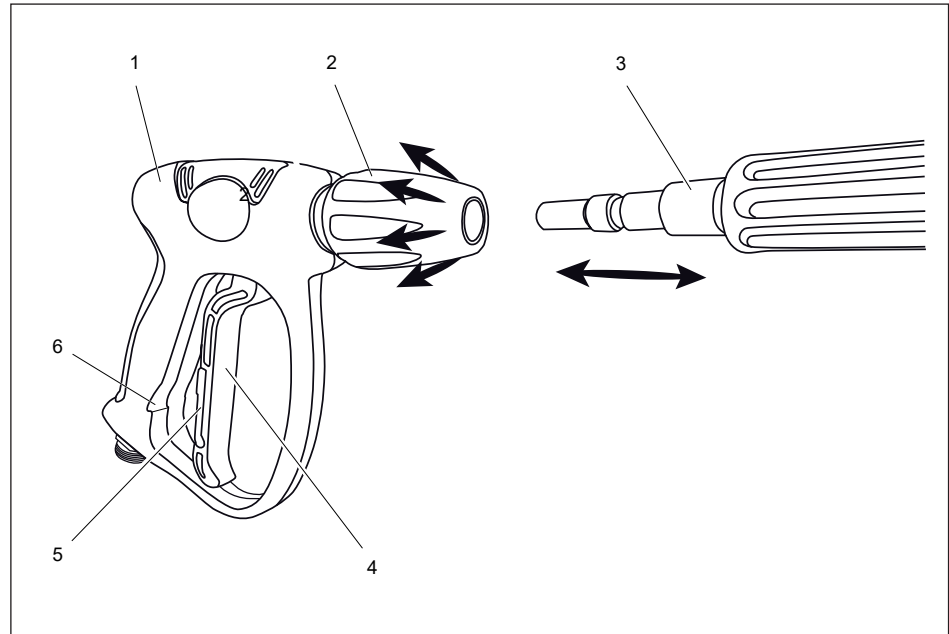

- | | | | |
|---|-------------|---|-------------------------------------|
| 1 | Trigger gun | 4 | Trigger lever |
| 2 | Quick lock | 5 | Locking lever (safety device) |
| 3 | Spray lance | 6 | Notch for locking lever (arresting) |

Fig. 6 - 2 Control elements of trigger gun

6.3 EMERGENCY STOP switch-off in case of danger



WARNING

In case of electrical accidents, never directly touch persons exposed life-threatening voltages.

In the event of accidents with persons at life-threatening voltages, immediately switch off the supply voltage to the high pressure cleaner or disconnect the power supply cable from the infrastructure mains plug. If possible, switch off the circuit breaker for the mains voltage.

Never touch the exposed person who has been involved in an accident directly. First aiders are also endangered by electric shock if they touch the person directly, in wet areas or over wet objects.

In extreme emergencies, without touching the injured person, use a dry garment, wooden slat or other insulating material to separate the person and mains voltage.

In case of accidents with persons or for accident prevention during device operation, perform an EMERGENCY STOP switch-off as follows:

- ▶ If necessary, if persons are still exposed to electric shock, switch off the mains voltage to the device via the circuit breaker (building connection) or disconnect the power supply cable from the mains socket.
- ▶ If necessary, switch off the device switch On/Off (2, Fig. 6 - 1) (to position 0).
- ▶ If necessary, activate the trigger gun (1, Fig. 6 - 2) until the high pressure cleaner is depressurised.
- ▶ If necessary, close shut-off valve for water supply (water mains).

6.4 Cleaning operation



WARNING

Danger of electric shock.

In the event of accidents (e.g. due to life-threatening voltages) involving persons or to prevent accidents, switch off the device (see Section 6.3, EMERGENCY STOP - Switch-off in case of danger).

The water jet emerging from the trigger gun must not be directed at live electrical components or devices (machines, devices, lines, sockets, etc.).

Before cleaning, disconnect the cleaning objects such as electrical devices, assemblies or components from the power supply.



WARNING

Ensure that the high pressure jet is used correctly.

The water jet coming out of the trigger gun must not be directed at persons or animals.

In the event of accidents (e.g. danger to persons, injured persons in the work area) or to prevent accidents, switch off the device (see Section 6.3, EMERGENCY STOP - Switch-off in case of danger).

To carry out cleaning work, proceed as follows:

- ▶ Unlock and pull the trigger lever (4, Fig. 6-2) of the trigger gun.



WARNING

Before activating, hold the trigger gun and the spray lance tightly.

After activation of the trigger gun the emerging water jet exerts a jerky recoil force (see also Fig. 6 - 3).

This may result in unintentional jerking away from the selected cleaning object or the trigger gun slipping out of the hand, endangering the life and limb of persons.

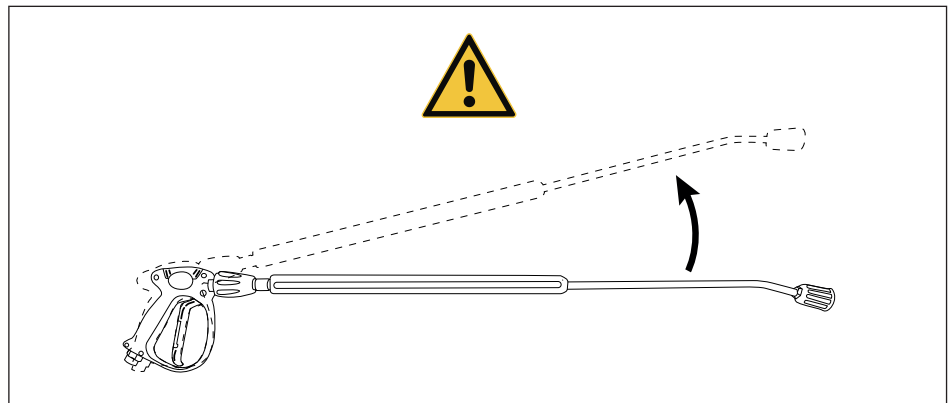

Fig. 6 - 3 Recoil force when switching on the trigger gun



WARNING

Danger of burns and scalds by hot surfaces or water.

The device is designed for a water inlet temperature of up to 45 °C. During operation with hot water inlet, surfaces of device parts or cleaning objects may get hot (parts of pump, metal parts of spray lance etc.).

Touching hot surfaces or hot water can cause burns or scalding of the skin surface. Avoid contact with hot water.

Make sure surfaces of device parts or water have cooled before touching.

- ▶ Set device switch On/Off (2, Fig. 6 - 1) into position I. The high pressure cleaner starts. The pump first delivers air from the high pressure nozzle. After a short time, water then escapes.
- ▶ Set the unloader valve (4, Fig. 6 - 1) to the desired operating pressure. By turning the unloader valve clockwise, the operating pressure increases - turning counterclockwise it decreases.
- ▶ The operating pressure can be read off the pressure gauge (3, Fig. 6 - 1) while the trigger gun (1, Fig. 6 - 2) is activated.
- ▶ If the trigger lever on the trigger gun is released, the high pressure cleaner switches to pressureless circulation operation. After approx. 30 sec. the device switches to stand-by mode. When the lever on the trigger gun is pulled again, the motor and the pump restart automatically.



General Information

If the device remains in stand-by mode for 20 minutes, the electronic control switches the high pressure cleaner off as programmed.

To resume operation, move the device switch On/Off into position 0 and then back to operating position I.

- ▶ For safety reasons after completion of cleaning work
 - Switch off the device via the device switch On/Off (into position 0).
 - Lock the trigger lever (4, Fig. 6-2) of the trigger gun against unintentional switching on using the locking lever (5, Fig. 6-2). Ensure that the locking lever is correctly arrested in the notch for locking lever (6, Fig. 6-2).

6.5 Operation with cleaning detergent (chemistry)



WARNING

Only use permitted detergents.

Only use cleaning detergents approved by the manufacturer EHRLE. The use of inadmissible detergents can endanger the operational safety of the device and thus the life and limb of persons.

There is a risk of poisoning or caustic burns with cleaning detergents. Observe the manufacturer's instructions. Keep cleaning agents out of the reach of unauthorized persons.

Observe specifications for neutral additive pH value 7 ... 9. Observe the instructions of the additive manufacturer, e.g. Personal Protective Equipment (PPE), waste water regulations.



WARNING

Risk of explosion due to use of inadmissible detergents.

Never aspirate solvent-containing liquids such as paint thinners, petrol, oil or similar liquids. The spray of solvents is highly flammable, explosive and toxic.

Observe the specifications of the additive manufacturers!

6.5.1 General Informationen



General Information

For operation with cleaning agents, the spray lance 900 mm with vario nozzle is also used with the Premium Version.

The spray lance 900 mm with the rotary nozzle is not used for operation with cleaning agents.

For cleaning work with the high pressure cleaner, a cleaning agent (chemical) can be added to the high pressure jet.

In order to protect the environment, we recommend using detergents sparingly. Observe the dosage recommendations on the container labels of the detergents.

An up-to-date list of approved detergents or chemical additives can be requested from the manufacturer EHRLE.

6.5.2 Cleaning detergent operation



CAUTION

Chemical dry run or inadmissible detergents can damage the device.

Before starting cleaning detergent operation, make sure that the cleaning agent container is sufficiently filled with cleaning agent.

Intake air or inadmissible detergents causes damage to seals and pumps.

For operation with cleaning detergents proceed as follows:

- ▶ Check the detergent container for filling, top up with approved detergent if necessary.
- ▶ Turn adjustable nozzle (1, Fig. 6-4) on the spray lance (2, Fig. 6-4) counterclockwise (direction „-“). During operation, the cleaning detergent is now automatically sucked in via the high-pressure injector and mixed with the high-pressure jet.
Depending on the setting of the adjustable nozzle, the cleaning detergent supply is dosed. Left stop is max. detergent dosage.
- ▶ To remove the dirt spray the cleaning detergent sparingly onto the cleaning object and let it work for approx. one to five minutes.
- ▶ Then spray off the loosened dirt with the high-pressure jet.
- ▶ After using cleaning detergents, switch the high pressure cleaner to normal operation and rinse for at least 30 seconds.
For normal operation, turn the adjustable nozzle (1, Fig. 6-4) on the spray lance clockwise (direction „+“) to right stop. The cleaning agent is no longer admixed to the high-pressure jet.

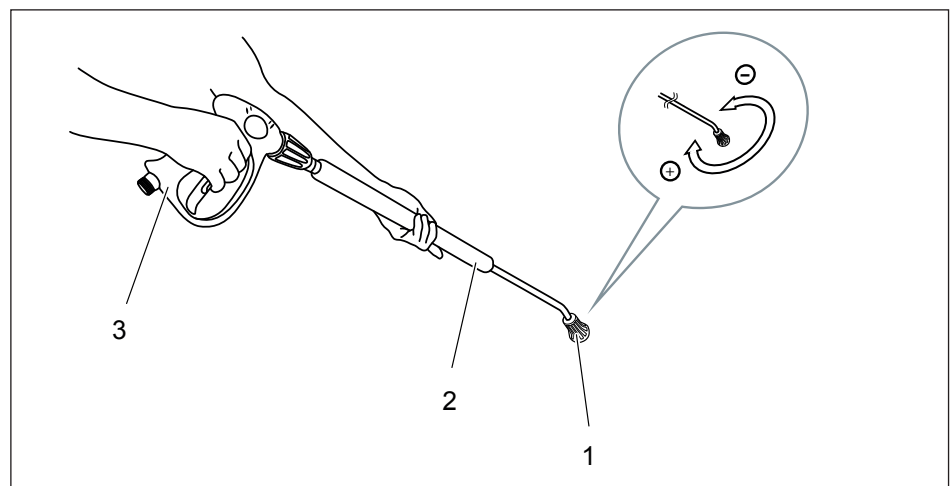

- 1 Adjustable nozzle
- 2 Spray lance
- 3 Trigger gun

Fig. 6 - 4 Setting the adjustable nozzle of the spray lance

7 Decommissioning



General Information

Provide a frost sheltered location for the high pressure cleaner as well as all accessories (trigger gun, spray lance, water inlet hose, etc.) for

- temporary storage until the next operation or
- storage over a longer period of time.

Otherwise provide frost protection (see Section 8.3.1).

7.1 Temporary decommissioning

After completion of cleaning work for temporary decommissioning until the next use, proceed as follows:

- ▶ After using cleaning detergents (see Section 6.5.2), switch the high pressure cleaner to normal operation and rinse for at least 30 seconds. To return to normal operation, turn the adjustable nozzle (1, Fig. 6-4) on the spray lance clockwise (direction „+“) to right stop. The cleaning agent is no longer admixed to the high-pressure jet.
- ▶ Switch off the device via device switch On/Off (2, Fig. 6 - 1) (into position 0).
- ▶ Close the water supply from the tap water network via the shut-off valve.
- ▶ Remove water inlet hose from
 - filter on connection water inlet (see Section 3).
 - fittings of the water supply network or water tap.
- ▶ Pull the trigger lever (4, Fig. 6-2) of the trigger gun until the high pressure cleaner is depressurised.



WARNING

Lock the lever of the trigger gun after completion of cleaning work.

After deactivating the trigger gun, lock the trigger lever (4, Fig. 6-2) against unintentional switching on by means of the locking lever (5, Fig. 6-2). Ensure that the locking lever is correctly positioned in the notch for the locking lever (6, Fig. 6-2).

Unintentional activation of the trigger gun after restarting the device can endanger life and limb of persons.

- ▶ Lock the trigger lever (4, Fig. 6-2) of the trigger gun against unintentional switching on using the locking lever (5, Fig. 6-2). Ensure that the locking lever is arrested in the notch for locking lever (6, Fig. 6-2).
- ▶ Remove HP-Hose from the trigger gun.
- ▶ To empty the high pressure pump, hold the HP-Hose and switch on the device only until no more water escapes at the end of the hose.
- ▶ Disconnect the mains cable plug from the electrical mains socket.
- ▶ Wind up the power cable on the device holder.
- ▶ Roll up HP-Hose.
- ▶ Stow the accessories on the device holdings provided.

7.2 Decommissioning for a longer period of time

If the high pressure cleaner is to be taken out of operation for a longer period of time, refer to Section 7.1 and take it out of operation.

Store the device in a frost-protected room.

See also Section 8.3.1, Frost Protection.

8 Maintenance



WARNING

Carry out maintenance measures professionally.

Maintenance measures may only be carried out by authorised personnel (see Tab. 8-1)

Before carrying out any maintenance work, take the high pressure cleaner out of operation and disconnect it from the building's electrical power supply or from the mains junction box (e.g. on construction sites).

8.1 General Information

The maintenance measures must be carried out professionally, regularly and mean for the device:

- Guarantee of operational safety.
- Achieving a long service life.
- Maintaining the performance.

8.2 EHRLE Maintenance and Inspection Contract

With the sale of the high pressure cleaner the manufacturer EHRLE offers a maintenance contract or especially a safety inspection agreement. The maintenance contract includes:

- Maintenance and repair work
- Security inspection agreement.

The security inspection agreement includes the inspection according to

- Guidelines for Liquid Sprayers (see Section 2.7).

8.3 Maintenance work

Components which show increased wear or whose design duration has been exceeded or is exceeded before the next maintenance must be replaced as a precaution.

Replace defective parts. Only use spare parts recommended and approved by the manufacturer.

The following table contains the periodical maintenance work for the High Pressure Cleaner cold water, mobile - Series 2x2.

Period	Component	Measure	Authorized personnel
Daily	Trigger gun	Check if trigger gun closes tightly; check function of mechanical locking to prevent unintentional switch-on; replace defective trigger gun.	Trained operator
	HP-Hoses	Check the HP-Hoses (see Section 8.3.3).	Trained operator
	Electrical plugs and cables	Check plugs and cables for damage. Replace damaged plugs and/or cables immediately by an authorized customer service/electrical specialist.	Customer Service/ Electrical Specialist
	High pressure pump	Check pump for leakage. If more than 3 drops per minute call customer service.	Customer service
	High pressure pump	Oil leakage.	Customer service
Weekly	Water inlet filter.	Check filter for dirt and clean if necessary, see section 8.3.2.	Trained operator
	Filter from detergent hose	Check filter for dirt and clean if necessary.	Trained operator
Semi-annually or if required	Spray nozzle	Replace spray nozzle.	Trained operator
Semi-annually	High pressure pump	Oil change by customer service.	Customer service
Annually	Safety check for the high pressure cleaner	An qualified expert has to inspect the high pressure cleaners in accordance with the „Guidelines for liquid sprayers“, if necessary or at least every 12 months (see Section 2.7). The result of the test must be recorded in writing. Carry out a safety check in accordance with the respective national regulations of the legislator for liquid sprayers.	Qualified expert

Tab. 8 - 1 List of maintenance work

8.3.1 Frost Protection

For optimum protection, operate or store the device in a frost-protected area.

If the device is exposed to temperatures below freezing point during temporary or prolonged decommissioning (e.g. storage in warehouse), frost protection must be provided (see Section 8.3.1.1 and Section 8.3.1.2).

8.3.1.1 Drain water from high pressure cleaner

Proceed as follows:

- ▶ Unscrew the water supply hose and the HP-Hose.
- ▶ Operate the high pressure cleaner for max. one minute until the pump and hoses are empty.

8.3.1.2 Rinse high pressure cleaner with antifreeze agent



General Information

Observe the handling instructions of the antifreeze manufacturer.

Proceed as follows:

- ▶ Provide commercially available antifreeze to the connection water inlet and connect the water supply hose.
- ▶ Place the collecting container under the high pressure outlet.
- ▶ Switch on the high pressure cleaner and operate until the antifreeze emerges at the high pressure outlet.

It also provides corrosion protection.

8.3.2 Filter on the connection water inlet

To clean the filter proceed as follows:

- ▶ Close the water supply from the tap water network via the shut-off valve.
- ▶ Unscrew the water inlet hose from the device filter.
- ▶ Unscrew the filter from the connection water inlet.
- ▶ Rinse the filter with clear water.
- ▶ Reassemble in reverse order.

8.3.3 Checking the HP-Hoses



WARNING

Operation with worn, damaged or repaired HP-Hoses can endanger life and limb of persons.

Ensure that HP-Hoses are removed immediately in the case of:

- Signs of wear.
- Signs indicating repairs to the HP-Hose.
- Overaging and low durability.

Bursting or leaky HP-Hoses can cause hot high pressure water or steam to escape. This can endanger life and limb of persons.

Before each commissioning of the high pressure cleaners, carry out a visual inspection of the HP-Hoses for damage. Every HP-Hose must comply with the safety regulations and be marked with:

- Permissible operating pressure.
- Permissible operating temperature.
- Date of manufacture.
- Manufacturer.

Replace the HP-Hose at the slightest sign of damage.

Only use spare parts recommended by the manufacturer (see spare parts catalogue).

9 Troubleshooting



WARNING

Carry out troubleshooting and rectification properly.

Maintenance measures may only be carried out by authorised personnel (see Tab. 9-1).

Before carrying out any troubleshooting activities, take the high pressure cleaner out of operation and disconnect it from the building's electrical power supply or from the mains junction box (e.g. on construction sites)

9.1 Troubleshooting table

The following table lists possible causes of failures.

Clean the contaminated parts (filter, high pressure nozzle etc.) to eliminate the fault.

Replace defective parts. Only use spare parts recommended and approved by the manufacturer

Error	Possible cause	Remedying	Authorized personnel
Device cannot be switched on.	Check that the power supply cable is plugged in.	Connect the power supply cable to the building power supply or mains junction box.	Trained operator
	Building supply or mains junction box circuit breaker has tripped.	Switch the circuit breaker on again.	Trained operator
	Circuit breaker trips again after repeatedly switched on.	If building power supply or mains junction box is ok, the device is defective; disconnect power supply cable and contact customer service.	Customer service
	Check if power supply cable is defective.	Replace defective power supply cable.	Customer Service/ Electrical Specialist
	Internal control circuits or components defective.	Replace defective components.	Customer service
Device has switched off in stand-by mode.	Device was in stand-by mode for 20 minutes. Electronic control has switched off high pressure cleaner according to program.	To resume operation, turn the device switch On/Off into position 0 and then back to operating position I	Trained operator

Tab. 9 - 1 Troubleshooting table

Error	Possible cause	Remedying	Authorized personnel
Pump operation unstable, provides no performance during cleaning agent operation.	External detergent container is empty or not filled sufficient. Filter of the detergent suction hose not inserted to the bottom of the detergent container.	Fill or top up (if necessary) the detergent container with approved detergent. Insert the filter of the detergent suction hose to the bottom of the detergent container	Trained operator
Device switched off during operation.	Motor of high pressure cleaner overheated.	Allow motor to cool down, set device switch into position 0, then switch on again (into position I).	Trained operator
	After further switch-on attempts, the device does not return to normal operation.	Contact customer service.	Customer service
	Internal control circuits or components defective.	Replace defective components.	Customer service
No pressure build-up with high pressure cleaner.	High pressure nozzle dirty or defective.	Clean or replace high pressure nozzle.	Trained operator
	Filter on the connection water inlet dirty.	Clean the filter, see Section 8.3.2.	Trained operator
	Water inflow volume is too low.	Ensure sufficient water inflow volume.	Trained operator
	Air has been sucked into the device, water supply or hose.	Vent the device or hoses.	Trained operator
	One or more supply lines of the pump are leaking.	Replace leaking supply lines.	Customer service
	Unloader valve contaminated.	Clean the unloader valve.	Customer service
	Unloader valve is defective.	Replace defective unloader valve.	Customer service
	High pressure pump valves are dirty or defective.	Clean or replace valves.	Customer service
Cuffs of the high pressure pump are dirty or defective.	Clean or replace cuffs.	Customer service	

Tab. 9 - 1 Troubleshooting table



10 Notes



Test report

for the annual safety inspection in accordance with the insurance association

Certificate

Prüfprotokoll EHRLE Hochdruckreiniger Test report EHRLE High-Pressure-Machines	<input type="checkbox"/> KD523 Std/Prem <input type="checkbox"/> KD523-UK Std/Prem
Name der Prüfperson: Name of the Test-Engineer:	
Prüfspannung für alle KD2x2-Geräte Test voltage for each KD2x2-Device:	<input type="checkbox"/> 1/N/PE/AC/50Hz/230V-240V
Serien-Nummer: Serial-Number:	
Optische Sichtkontrolle außen: Visual inspection outside:	<input type="checkbox"/> Kontrolliert / Checked
Optische Sichtkontrolle innen: Visual inspection inside:	<input type="checkbox"/> Kontrolliert / Checked
Düsengröße: Nozzle size:	KD523 25043 (weiß)
Arbeits- und Abschaltdruck Einstellmaß Unloader in mm : Operating- and Switch-off pressure setting dimension unloader in mm:	<input type="checkbox"/> KD523 Std/Prem <input type="checkbox"/> KD523-UK Std/Prem
Unloaderventil schaltet bei geschlossener Pistole: Unloadervalve switching during closed trigger gun:	<input type="checkbox"/> Kontrolliert / Checked
Arbeitsdruck Kaltwasserbetrieb in bar: Operating pressure cold water mode in bar:	<input type="checkbox"/> KD523 Std / Prem 30 - 140 bar ist: <input type="checkbox"/> KD523-UK Std / Prem 30 - 140 bar ist:
Aufnahmeleistung bei max. Arbeitsdruck in A.: Electric consumption by max. operating pressure in A.:	<input type="checkbox"/> KD523 Std / Prem bis 16 A ist: <input type="checkbox"/> KD523-UK Std / Prem bis 13 A ist:
Zulässiger Arbeitsüberdruck bei geschlossener Pistole (max. 20-40 bar höher als Arbeitsdruck): Max. pressure closed trigger gun (max. 20-40 bar higher than operating-pressure):	
Zulässige Aufnahmeleistung Motor in A.: Max. overload motor in A.:	<input type="checkbox"/> KD523 Std / Prem 3,0kW AC230/240 13,2 <input type="checkbox"/> KD523-UK Std / Prem 3,0kW AC230/240 12,9
Dichtheitskontrolle bei Chemieansaugung unter max. Arbeitsdruck: Tight control under max. operating pressure:	<input type="checkbox"/> Kontrolliert / Checked
Gerätabstaltung prüfen TSS (Total-Start-Stop)-System: Check TSS-system:	<input type="checkbox"/> Kontrolliert / Checked
KD-Reiniger entwässert: Water drained:	<input type="checkbox"/> Kontrolliert / Checked
Frostschutzmaßnahme prüfen: Check frost protection:	<input type="checkbox"/> Kontrolliert / Checked
Bemerkung: Notes:	
Datum: Date:	
Unterschrift Prüftechniker: Signature Test-Engineer:	

Proof of customer service

Device type	Manufacture no.:	Commissioning on:
-------------	------------------	-------------------

Inspection carried out on:

Findings:

Signature

Inspection carried out on:

Findings:

Signature

Inspection carried out on:

Findings:

Signature

Inspection carried out on:

Findings:

Signature

EHRLE GmbH • D-89165 Dietenheim / Germany

EHRLE service near to you? Adresses, phone numbers etc. you will find under www.ehrle.com

Subject to change without notice. Reprint prohibited.

